

RELIANCE



SG-720 USER MANUAL

⚠ WARNING: Batteries, battery posts, battery terminals, and related accessories can expose you to chemicals including lead and lead compounds, which are known to the State of California to cause cancer and birth defects or other reproductive harm. For more information, go to P65Warnings.ca.gov

Table of Contents

Safety Instructions/Precautions 2

Built-In Safety Features 4

Introduction 5

Operation 10

Faults 11

Warranty Information 12

Parameters & Dimensions 13

***Thank you for purchasing a Reliance SG-720
High Frequency Industrial Battery Charger!***

If you experience any issues with this product or have any questions, please see contact info on the back of this user manual.

IMPORTANT Safety Instructions/Precautions

Model: SG-720 (High Frequency Industrial Charger)

Before using this battery charger, read all instructions and warning labels on charger and vehicle.

Reduce risk of injury, property damage, and/or fire: if you do not carefully read and follow these safety instructions, injury, death, property damage, and/or fire can occur.

DANGER – Risk of Electric Shock:

- Always disconnect the charger handle from the vehicle and unplug the AC power before servicing vehicle. By only turning off the charger there is still risk of electric shock.
- Never touch the uninsulated portion of the AC or DC connectors or uninsulated battery terminals.
- Ensure all electrical connectors are in good working condition: do not use cracked or corroded connectors or those that make poor electrical contact. Use of damaged connectors can result in electric shock and/or overheating.
- Do not attempt to disassemble, modify, or service charger. No user serviceable parts are inside. Service must be performed by a qualified service technician. Improper reassembly can result in explosion, fire, or electrical shock. Contact technical support if the charger is not working properly. Attempting to disassemble the charger will void all remaining warranty.
- Always connect to a properly grounded 3-wire outlet. Never modify the AC cord. If it will not fit an outlet, have the proper outlet installed by a qualified electrician. Extension cords are not recommended, but if used must be a 3-wire grounded cord of at least 14AWG and less than 25 ft long. Improper extension cords may result in electrical shock or fire.

WARNING:

- To reduce risk of fire, do not use near flammable materials or vapors. Always install or use the charger on a non-combustible surface (metal, brick, concrete, etc).
- Lead acid batteries generate hydrogen gas which can explode if ignited. Never smoke near batteries. Never allow conductive objects such as wrenches, jewelry, or other metal to connect across battery terminals. Do not disconnect the DC charging cord while charger is operating. This can cause arcing and/or explosion.
- Always ventilate enclosed areas during charging to prevent buildup of explosive hydrogen gas.
- Lead acid batteries contain sulfuric acid. When working on or near batteries always wear eye/face protection (goggles, face shield, etc). Protective gloves are recommended. If acid contacts eyes, flush with clean water for 15 minutes and seek immediate medical attention. If acid contacts skin, immediately wash thoroughly with soap and water. If any burns or other complications occur, seek medical attention. If acid contacts clothing, clean thoroughly and separately from any other clothing and allow to completely dry.
- Never charge a frozen or non-rechargeable battery as they may explode, causing injury, death, property damage, and/or fire.
- Always keep cell phones away from batteries while in the charging process. Cell phones can create sparks which can lead to explosions causing personal injury or damage or death.

CAUTION:

- Ensure your vehicle has the same type of batteries installed as shown on the label before charging (voltage/cell count/amp hour capacity). Other types of batteries may explode, causing personal injury or damage.
- Use only with flooded lead-acid batteries. This charger may not be used with VLRA (sealed), AGM or gel type batteries. Using this charger with other types of batteries may cause explosion, injury, fire, or damage. Additionally, the use with other batteries may also void the battery, vehicle, and/or charger warranties.
- Never operate this charger if it has received any physical damage, been dropped, or received a sharp blow. Always have a qualified service repair technician examine and repair as needed.
- Ensure that the vehicles battery system has the properly rated voltage, amp hours and type (flooded lead acid) for this charging system.

KEEP THIS MANUAL:

Ensure this manual is saved in a location where it is readily available for anyone who may need to operate this charger.

Failure to follow these instructions could result in serious damage to you and/or your vehicle. Please read this manual in its entirety prior to charger operation.

Built-In Safety Features

OVER TEMPERATURE PROTECTION

If the charger exceeds normal operating temperatures, power output will be decreased until regular operating temperatures resume. If the charger exceeds 149° F, the charger will automatically stop charging and go into standby mode until normal operating temperatures are detected and charging can safely be resumed.

REVERSE POLARITY PROTECTION

If one or more batteries are connected improperly, the charger will automatically shut down to prevent any potential damage to the batteries.

NO LOAD PROTECTION

When the charger DC paddle is disconnected, the charger will provide zero output to the DC output connection.

SHORT CIRCUIT PROTECTION

If a short-circuit is detected, the charger will automatically shut down. Once the short circuit is rectified, the charger will resume its normal charging status.

AUTO SHUT DOWN

When the batteries reach the fully charged state the charger will automatically shut down and provide zero DC output and a solid green light.

Introduction

Unpacking and Inspection

- When unpacking your Reliance SG-720 charger be sure to inspect for any damage that may have occurred during shipping. If you identify any shipping damage, please report the issue as a claim with the freight company.
- Do not operate the charger if there is any damage to the unit, the AC cord or the DC cord/paddle.

Charger Mounting Recommendations

The Reliance SG-720 charger has four mounting holes and two hanger holes in the aluminum base to allow the end user multiple mounting configurations.

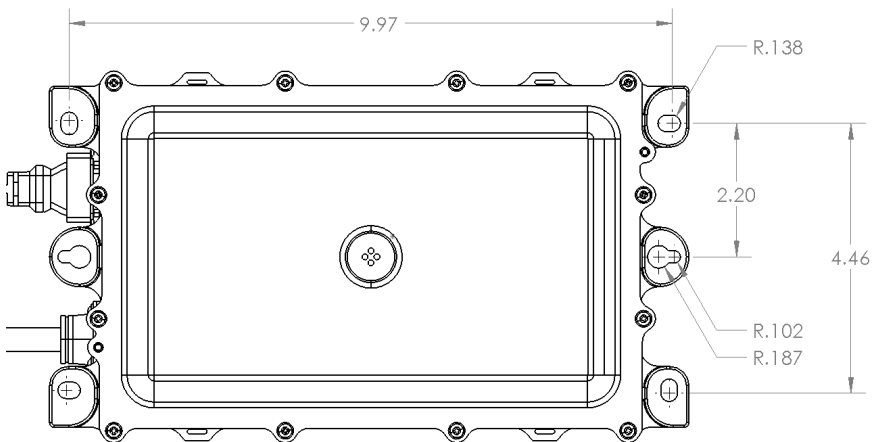

When mounting the Reliance SG-720 charger, 1/4 - 20 nuts and bolts are recommended to secure the charger. Using screws is not recommended. The center holes can be used with a securely mounted hook to hang the charger.

This charger can be mounted in several different configurations:

1. Preferred mounting orientation

- Horizontally flat mounted with fan (handle) facing upwards with no obstruction
- Vertically mounted with AC/DC cords facing up or down
- Side mounted with AC/DC cords facing left or right

2. Non-Preferred Mounting Orientation

- Horizontally mounted with fan (handle) facing the ground

NOTE: Always mount the charger to a noncombustible material surface (metal/ brick/concrete). When choosing an installation location, ensure there is space around the fan to provide sufficient cooling - at minimum 3 inches.

Battery Types

- The Reliance SG-720 should only be used with deep cycle flooded lead acid batteries produced by the following manufacturers: Trojan, JCI, Crown, and U.S. Battery. The charge profile for this charger is optimized for Trojan 6 x T-105 (36V), 6 x T-875 (48V) or 4 x T-1275 (48V) depending upon the model selected.
- Using this charger with other types of batteries may cause explosion, injury, fire, and/or damage. Additionally, use with other batteries may void the battery, vehicle, and/or charger warranties.
- Ensure you observe all battery manufacturers precautions.

AC Input

- The Reliance SG-720 is designed to accept an AC input range of 90-120 VAC (45-65 Hz).
- The max current rating for the Reliance SG-720 is 7A @ 111VAC.
- The charger may reduce its output power if its supply voltage drops below 90 volts.
- The supplied AC power cord must be used with an outlet that is properly installed and grounded in accordance with all applicable electric codes and ordinances.

NOTE: Never use the charger with a damaged AC cord or plug. Extension cords are not recommended, but if used must be a 3-wire grounded cord of at least 14AWG and less than 25 ft long. Improper extension cords may result in electrical shock or fire.





DC Output

- The DC output cord set includes a commonly used connector/plug. The polarity of the charger DC connector/plug must be the same as the battery connector. The BLACK DC cable must be connected to the battery negative (-), and the WHITE or RED DC cable must be connected to the battery positive (+). This charger will not operate if the polarity is reversed.

NOTE: The Reliance SG-720 charger does not activate vehicle charger interlock features which prevent movement while plugged in. Always disconnect the DC paddle prior to attempting to move the vehicle.

Charging

With the DC Charger Paddle installed in the vehicles charger receptacle the LED indicator will illuminate one of the following patterns:

 ---	Charging 0%-19%: Red flash, pause for 3 seconds
	Charging 20%-79%: Red flash, pause for 1 second
	Charging 80%-99%: Yellow flash, pause for 1 second
	Charged 100%: Solid green light
	Idle, Precharge Diagnostics, or Error: Red-green flash (see faults on reverse)

- The Reliance SG-720 charger will stop charging once batteries reach 100% state of charge, indicated by a solid green LED status light.
- Once the charge cycle is complete, the charger will go into a float charge mode. In this mode, the charger continuously monitors battery voltage; the charger will turn on after 30 days or when battery state of charge reaches 80%, whichever comes first. Once state of charge reaches 100% again, the charger will turn off and return to float charge mode.
- Battery charge times can vary due to numerous factors (depth of discharge, battery age, battery amp hour capacity).

Charging Location

- Always use charger in a well-ventilated area. Lead acid batteries generate hydrogen gas which can explode if ignited. Never smoke near batteries and keep sparks/flame away.
- If using an extension cord is absolutely necessary, please refer to the precautions outlined in this instruction manual.
- This charger is not intended for use as an on-board charger. Modifying charger for on-board use will void the warranty of the charger, vehicle, and/or batteries.

Charger Maintenance

- If cleaning is required, always ensure the DC charger paddle is disconnected from the golf cart charging port and the AC cord is unplugged from the wall outlet.
- Never use any type of cleaning solvents on the charger. Use a slight damp soft cloth to clean the charger.





















Operation

1. Connect the AC power cord to a 3-prong grounded wall outlet. Ensure the DC paddle is not connected to the vehicle prior to insertion of the AC power cord. LED indicator will flash red/green/red/green repeatedly.
2. Insert the DC paddle into the vehicle's charger receptacle. The charger's built in fan will turn on and the LED indicator will continue to flash red/green while determining the battery pack capacity and the ambient temperature. Wait for the LED indicator light to indicate the charge status (this can take up to 90 seconds – if the charger does not indicate that it is charging, unplug it and see the troubleshooting steps on page 11).
3. The charger will automatically start. The LED indicator will indicate the state of charge (see page 8).

NOTE: During the charge cycle, if it becomes necessary to disconnect the charger, first disconnect the AC power cord from the wall outlet. You may then proceed to remove the DC paddle from the vehicle's charger receptacle.

4. When the batteries reach their full charge cycle the LED status indicator will illuminate solid green. When this occurs, the charger will auto terminate.
 - Charging times can vary due to numerous conditions as described in Introduction.
5. Before you prepare to drive the vehicle, you must disconnect the DC charger paddle from the vehicles charger receptacle by firmly grasping the DC charger paddle and pulling it straight out of the receptacle.
6. When the DC charger paddle has been removed, unplug the charger from the AC wall outlet (If not frequently used).
7. Store the charger in a safe place when not in use.

Reliance SG-720 Charger Faults

Error	LED Flash Pattern	Resolution
No-Load (Idle)	   	Check connections of batteries and of charger. Check for low battery voltage.
Over-Voltage or Current	   -	Unplug charger from wall and vehicle, wait 5 minutes, and try again.
Over or Under Temperature	    -	Verify that ambient temperature is between -22 °F and 149 °F. Make sure charger and vehicle are well-ventilated.
Charger Overheat	  -	Make sure charger is well ventilated and cooling fan is functioning.
Charger Under-Voltage	  -	Contact Tech Support.
Input AC Abnormal	     -	Check the input voltage and plug contact.

After flash pattern repeats 5 times, charger will flash **Green-Red-Green-Pause** before repeating.

If error resolutions above do not resume normal charging, contact Tech Support. **Do not continue to attempt to use the charger.**

Warranty

The Reliance SG-720 Industrial battery charger comes with an 18-month limited warranty.

This is a non-transferable 18-month limited warranty available only to the original end user. The warranty coverage starts on the date of purchase. Within this coverage period, any manufacturer's defect will warrant a full replacement charger at zero cost to the consumer, excluding any replacement shipping costs.

EXCLUSIONS & LIMITATIONS

- This warranty does not cover any commercial or rental usage of the charger and such use of the charger shall void the warranty.
- The warranty does not cover normal wear and tear of the charger including, but not limited to, minor cosmetic damage and blemishes.
- Damages outside of normal wear and tear caused by accident, misuse or modification will not be covered by this warranty.
- The purchaser is responsible for the cost of regular maintenance or replacement parts outside the scope of the limited warranty. Before using the charger, the purchaser is responsible for determining the compatibility of the charger with their vehicle charging application.

Parameters & Dimensions

Length	10.6 in
Width	6.2 in
Height	3.2 in
Height w/Handle	4.5 in
Weight	7.5 lbs
AC Cord Length	8 ft
DC Cord Length	8 ft

Operating Temp	-22 °F to 149 °F
Storage Temp	-40 °F to 176 °F
Altitude	0-6500 feet
Humidity	5% to 95%

DC Output Current	15A @ 48V; 20A @ 36V
--------------------------	----------------------

AC Input Voltage Range	90 - 120VAC; 45 - 65Hz
AC Input Max Current	8.0A @ 100VAC
Power Factor	>0.98
Efficiency	>94.0%
Noise	<50dB
IP (Ingress Protection) Rating	IP65

Compliance

This product meets UL1012:2010 R4.16, DOE 10 CFR Part 430, CAN/CSA-C22.2 No. 107.2-01+G11+G12 (R2016), and CEC 400-2017-002 standards. Additionally, it complies with the Electromagnetic Compatibility Directive 2014/30/EU, FCC Part 15, and Industry Canada’s ICES 003 for a Class A digital device. Operation is subject to the following:

- Device may not cause harmful electromagnetic interference
- Device must accept any interference received, including interference that may cause undesired operation

Product Recycling/Disposal

All end users of the charger must comply with relevant local laws and regulations when recycling or otherwise disposing of the charger.

NEED HELP?



800-959-0852



techsupport@nivel.com



nivel.com/specialtyvehicles

HOURS

Monday to Friday: 8am - 7pm

Saturday: 9am - 2pm

Sunday: Closed